

FLOOREQUIPMENTPARTS.COM



# 1200

U.S. Patent No. 美國專利號碼：  
4,956,891

**Portable Carpet Extractor**  
**攜帶式地氈污垢抽洗機 (extractor)**

**Model No. 機型號碼：**  
**611468-230V**

**Operator**  
**操作手冊**

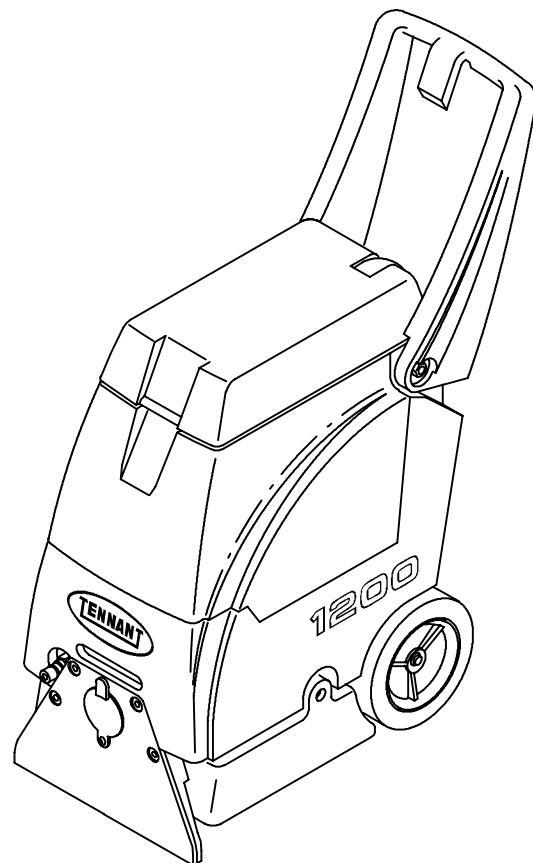

**611383**  
**Rev. 版本 : 01 (05-04)**

# OPERATION 操作

This manual is furnished with each new model. It provides necessary operation and maintenance instructions and an illustrated parts list.

**Read this manual completely and understand the machine before operating or servicing it.**

Use the illustrated Parts Lists to order parts. Before ordering parts or supplies, be sure to have your machine model number and serial number handy. Parts and supplies may be ordered by phone or mail from any authorized parts and service center, distributor or from any of the manufacturer's subsidiaries.

This machine will provide excellent service. However, the best results will be obtained at minimum costs if:

- The machine is operated with reasonable care.
- The machine is maintained regularly – per the maintenance instructions provided.
- The machine is maintained with manufacturer supplied or equivalent parts.

## MACHINE DATA

Please fill out at time of installation for future reference.

Model No. – \_\_\_\_\_

Install. Date – \_\_\_\_\_

Serial No. – \_\_\_\_\_

Specifications and parts are subject to change without notice.

各種新的機型都附有本手冊，它提供必要的操作和維修指示以及一份圖示的零件清單。

**在操作或維修之前，請先讀完本手冊，並了解此機器的功能和特性。**

利用圖示的零件清單來訂購零件。在訂購零件或補充配件之前，請確定您的機型號碼和序號。零件和補充配件可利用電話或郵政，向任何授權的零件和服務中心、經銷商或製造商的分處訂購。

本機器將提供優良的維修服務。不過，要能以最少的投入獲得最好的結果，其前提是：

- 機器在有合理照顧的狀況下操作。
- 機器有定期維修。
- 機器維修是使用製造商所提供或相同質量的零件。

## 機器的資料

安裝時，請填此表，以供將來參考之用。

機型號碼 – \_\_\_\_\_

安裝日期 – \_\_\_\_\_

序號 – \_\_\_\_\_

規格或零件若有更改，恕不另行通知。

## TABLE OF CONTENTS

## 目錄

<b>SAFETY PRECAUTIONS 注意事項</b> .....	4	<b>RECOMMENDED STOCK ITEMS</b>	
GROUNDING INSTRUCTIONS 接地指示 .....	5	建議的庫存項目 .....	15
<b>SAFETY LABELS 安全標籤</b> .....	6	<b>TROUBLE SHOOTING 故障排除</b> .....	16
<b>MACHINE COMPONENTS 機器元件</b> .....	7	<b>SPECIFICATIONS 規格</b> .....	18
<b>MACHINE SETUP 機器設定</b> .....	7	<b>MACHINE DIMENSIONS 機器尺寸</b> .....	18
<b>MACHINE OPERATION 機器操作</b> .....	9		
PRE-OPERATION 前置作業 .....	9		
CLEANING CARPETS 清洗地氈 .....	9		
WHILE OPERATING 操作時 .....	10		
CLEANING WITH ACCESSORY TOOLS			
利用附屬工具來清洗 .....	10		
<b>DRAINING TANKS 排水槽</b> .....	11		
DRAINING RECOVERY TANK 排水回收槽 .....	11		
DRAINING SOLUTION TANK 排水溶劑槽 .....	12		
<b>MACHINE MAINTENANCE 機器維修</b> .....	12		
DAILY MAINTENANCE 每日的維修 .....	12		
WEEKLY MAINTENANCE 每週的維修 .....	14		
MONTHLY MAINTENANCE 每月的維修 .....	14		
QUARTERLY MAINTENANCE 每季的維修 .....	15		
<b>STORING MACHINE 貯存機器</b> .....	15		

# OPERATION 操作

## SAFETY PRECAUTIONS

This machine is intended for commercial use. It is designed to clean carpet and upholstery in an indoor environment and is not constructed for any other use. Use only recommended cleaning solutions and accessory tools.

All operators must read, understand and practice the following safety precautions.

The following safety alert symbols are used throughout this manual as indicated in their description:

**⚠ WARNING: To warn of hazards or unsafe practices which could result in severe personal injury or death.**

**FOR SAFETY: To identify actions which must be followed for safe operation of equipment.**

The following information signals potentially dangerous conditions to the operator or equipment:

### FOR SAFETY:

#### 1. Do not operate machine:

- Unless trained and authorized.
- Unless operator manual is read and understood.
- In flammable or explosive areas.
- Unless cord is properly grounded.
- With damaged cord or plug.
- If not in proper operating condition.
- In outdoor areas.
- In standing water.
- With the use of an extension cord.

#### 2. Before operating machine:

- Make sure all safety devices are in place and operate properly.

#### 3. When using machine:

- Do not run machine over cord.
- Do not pull machine by plug or cord.
- Do not pull cord around sharp edges or corners.
- Do not unplug by pulling on cord.
- Do not stretch cord.
- Do not handle plug with wet hands.
- Keep cord away from heated surfaces.
- Report machine damage or faulty operation immediately.
- Follow mixing and handling instructions on chemical containers.

## 注意事項

本機器是針對商業用途而設計，用以清洗地氈和室內裝潢，不適用於任何其它方面。請只使用建議的清潔溶劑和附屬的工具。

所有的操作人員須閱讀、了解和執行下面的注意事項。

下面的安全警示符號遍布於本手冊中，如其說明所指示：

**⚠ 警告：是要警示可能導致個人嚴重傷害或死亡的觸電或是不安全的操作：**

**安全起見：確認所有操作必須根據機器的安全操作標準。**

下面的資訊暗示對操作人員或設備有潛在性危險的情況。

### 安全起見：

#### 1. 勿操作機器：

- 除非受過培訓和有授權。
- 除非讀過並了解操作手冊的。
- 在有火焰或爆炸性的區域。
- 除非電源線有適當接地。
- 當電源線或插頭損壞時。
- 若不是在正確的操作情況下。
- 在戶外區域。
- 在死水中。
- 在使用延長線時。

#### 2. 在操作機器之前：

- 請確定所有安全裝置都就位且操作正確。

#### 3. 使用機器時：

- 勿將機器輾過電源線。
- 勿抓著插頭或電源線來拉動機器。
- 勿在有尖銳的邊或角落的附近，拉電源線。
- 拔掉電源時，勿拉扯電源線。
- 勿伸展電源線。
- 勿用濕手處理插頭。
- 電源線遠離發熱的表面。
- 機器毀損或操作有錯誤時，立即回報。
- 遵循化學容器上的混合和處理指示。

## 4. Before leaving or servicing machine:

- Turn off machine.
- Unplug cord from wall outlet.

## 5. When servicing machine:

- Unplug cord from wall outlet.
- Avoid moving parts. Do not wear loose jackets, shirts, or sleeves.
- Use manufacturer supplied or approved replacement parts.

**⚠ WARNING: Hazardous Voltage. Shock or electrocution can result. Always unplug machine before servicing.**

**⚠ WARNING: Flammable materials can cause an explosion or fire. Do not use flammable materials in tank(s).**

**⚠ WARNING: Flammable materials or reactive metals can cause an explosion or fire. Do not pick up.**

## 4. 機器留置或維修之前：

- 先關掉機器。
- 從牆上的插座拔下電源線。

## 5. 機器維修時：

- 從牆上的插座拔下電源線。
- 避免移動零件，勿穿著寬鬆的夾克、襯衫、袖套。
- 使用製造商提供或認可的替換零件。

**⚠ 警告：危險高壓，可導致休克或觸電致死，維修之前，一定要拔下機器的電源。**

**⚠ 警告：易燃物可引起爆炸或起火，槽內勿使用易燃物。**

**⚠ 警告：易燃物或活性金屬可引起爆炸或起火，勿吸取。**

## GROUNDING INSTRUCTIONS

Machine must be grounded. If it should malfunction or breakdown, grounding provides a path of least resistance for electrical current to reduce the risk of electrical shock. This machine is equipped with a cord having an equipment-grounding conductor and grounding plug. The plug must be plugged into an appropriate outlet that is properly installed in accordance with all local codes and ordinances.

## 接地指示

機器須接地。萬一機器失常或故障，接地會提供電流一條阻抗最少的路徑，可減少觸電的危險。本機器配備一條具有設備接地導體和接地插座的電源線。插頭須插入正確安裝並符合當地法令的適宜插座上。

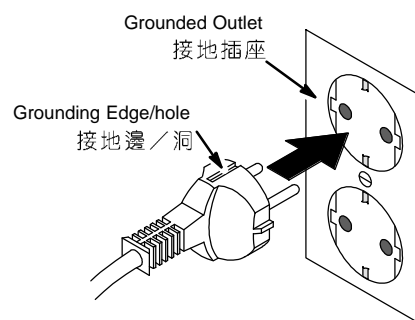

# OPERATION 操作

## SAFETY LABELS 安全標籤

The safety labels appear on the machine in the locations indicated. Replace labels if they become damaged or illegible.

安全標籤會出現在機器上所指的位置，如果破損或無法辨認時，請更換標籤。



**WARNING LABEL** – Located on cover. Label warns operator of safe practices of equipment -English text.

**警告標籤** – 位於蓋子上。標籤警告操作人員安全地操作設備-是英文的說明。

**FOR SAFETY LABEL** – Located on rear

**安全標籤** – 位於後側

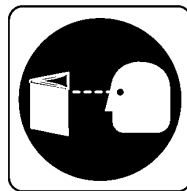

**FOR SAFETY:**  
Read manual  
before operating  
machine.

為了安全起見：  
操作機器之前，請先閱讀手冊。



**FLAMMABLE SPILLS LABEL** – Located near solution tank fill port and recovery tank

**易燃物溢出標籤** – 位於溶劑槽填裝口和回收槽



**WARNING:** Flammable materials can cause an explosion or fire. Do not use flammable materials in tank(s). Flammable materials or reactive metals can cause explosion or fire. Do not pick up.

**警告：**易燃物可導致爆炸或起火，槽內勿使用易燃物。易燃物或活性金屬可導致爆炸或起火，不要吸取。



## MACHINE COMPONENTS 機器元件



1. Main Power ON/OFF Switch  
電源切換開關(ON/OFF)
2. Brush/Solution Triggers  
刷子/溶劑觸發器
3. Pump Reset Button  
泵邊重設鈕
4. Brush Reset Button  
刷子重設鈕
5. Folding Handle  
摺疊式把手
6. Folding Handle Lock Lever  
摺疊式把手鎖定桿
7. Power Cord Hooks  
電源線掛鉤
8. Solution Tank Drain Hose with Solution Level Markers  
有溶劑水位標示器的溶劑槽排水管
9. Recovery Tank Cover  
回收槽蓋
10. Recovery Sight Window  
回收視窗
11. Recovery Tank  
回收槽
12. Solution tank  
溶劑槽
13. Floating Brush Base  
浮動式刷子基組
14. Pick-Up Head  
吸取頭
15. Accessory Tool Solution Hose Coupler  
附屬工具溶劑軟管耦合器
16. Accessory Tool Vacuum Hose Port  
附屬工具吸塵器軟管埠

## MACHINE SETUP 機器設定

1. Carefully check carton for signs of damage. Report damages at once to carrier. The machine is shipped fully assembled and is ready for use.
  1. 小心檢查硬紙箱是否有破損的跡像，有破損，請立即通知貨運人員，機器出廠時，都已完整組裝並能立即使用。
2. Adjust handle from transport position. To adjust, pull handle lock lever outward and lift handle to desired operating height, re-lock lever (Figure 1).
  2. 把在運輸位置的把手調整回來，若要調整，請將把手鎖定桿向外拉，將把手向上抬起至希望的操作高度，重新鎖定控制桿（圖 1）。



FIG. 1 (圖 1)

3. Hinge open cover and remove recovery tank from machine. Make sure the float shut-off screen and solution tank strainer are in place before use (Figure 2).
  3. 鏈住開啟蓋，從機器上移去回收槽。使用前，請確定浮動的阻斷濾網和溶劑槽過濾器已就位（圖 2）。



FIG. 2 (圖 2)

## OPERATION 操作

- Using a clean bucket or hose, fill solution tank with 15 L (4 gal) of hot water, 60 °C (140 °C) maximum (Figure 3). Observe solution tank hose at rear of machine when filling. The hose indicates the amount of water in solution tank (Figure 3).

- 用乾淨的水桶或軟管，把 15 公升（4 加侖）、最高 60 °C（140 °C）的熱水，裝入溶劑槽內（圖 3）。裝填時，觀察機器後側的溶劑槽軟管（圖 3）。

**ATTENTION: Do not use recovery tank to fill solution tank. Residual dirt or debris could cause damage to solution pump.**

注意：勿使用回收槽來填充溶劑槽。殘留的塵土或碎片可造成溶劑泵的損壞。

**⚠ WARNING: Flammable materials can cause an explosion or fire. Do not use flammable materials in tank(s).**

**⚠ 警告：易燃物可導致爆炸或起火，槽內勿使用易燃物。**



FIG. 3 (圖 3)

- Add a recommended cleaning chemical.
- 請添加所建議的化學清潔劑。

**FOR SAFETY: When using machine, follow mixing and handling instructions on chemical containers.**  
安全起見：使用機器時，請遵循化學容器上的混合和處理指示。

**ATTENTION: If using powdered cleaning chemicals, mix prior to adding.**

注意：若使用粉狀的化學清潔劑，添加前，請先攪拌。

**NOTE: If desired, water alone achieves excellent cleaning results.**

注意：如果願意的話，其實只用水便可達到絕佳的清潔效果。

- Replace recovery tank and close cover after filling.
- 填裝之後，請更換回收槽和關閉蓋。

- Plug machine's power cord into a grounded wall outlet (Figure 4).

- 將機器的電源線插入接地的牆上插座（圖 4）。

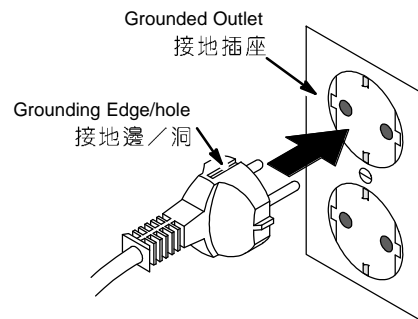

FIG. 4 (圖 4)

**FOR SAFETY: Do not operate machine unless cord is properly grounded.**

安全起見：除非電源線正確接地，否則勿操作機器。

**FOR SAFETY: Do not operate machine with the use of an extension cord.**

安全起見：使用延長線時，勿操作機器。



## MACHINE OPERATION 機器操作

**FOR SAFETY: Do not operate machine unless operator manual is read and understood.**

**安全起見：除非讀過並了解操作手冊，否則勿操作機器。**

### PRE-OPERATION 前置作業

1. Vacuum carpet and remove other debris.  
1. 用吸塵器打掃地氈，並除去其它的碎片。
2. Perform MACHINE SETUP procedures.  
2. 執行機器設定的程序。
3. Inspect power cord for damage.  
3. 檢查電源線是否損壞。

### CLEANING CARPETS 清洗地氈

1. Turn main power switch on (Figure 5).  
1. 開啟電源開關 (圖 5)。



FIG. 5 (圖 5)

2. To begin cleaning carpets, pull triggers and slowly pull machine backwards (Figure 6).
2. 若要開始清洗地氈，請拉觸發器並緩緩地將機器向後拉 (圖 6)。

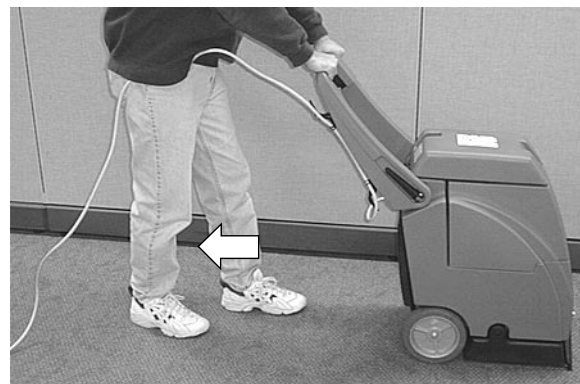

FIG. 6 (圖 6)

3. Release triggers at end of path and continue to pull machine to pick up excess solution.  
3. 在路線終點，放開觸發器，然後繼續拉動機器，吸取多餘的溶劑。
4. Tip machine back on wheels and push machine forward to begin next path.  
4. 以輪子為支撐點，將機器向後傾斜，然後將機器向前推，開始下一路線。

# OPERATION 操作

## WHILE OPERATING 操作時

1. Overlap each path by 50 mm (2 in).
1. 將每一路線重疊 50 公釐 (2 英吋)。

**⚠ WARNING: Flammable materials or reactive metals can cause an explosion or fire. Do not pick up.**

**⚠ 警告：易燃物或活性金屬可導致爆炸或起火，不要吸取。**

2. Work away from wall outlet and power cord to prevent cord damage.
2. 工作時，遠離牆上插座和電源線，以避免電源線受損。
3. Periodically check for excessive foam buildup in recovery tank. Use a recommended foam control solution to prevent vacuum motor damage.
3. 定期檢查回收槽內有否多餘的泡沫組織，請使用建議的泡沫控制溶劑，以避免吸塵器的馬達受損。

**ATTENTION: Excessive foam buildup will not activate the float shut-off screen.**

**注意：多餘的泡沫組織將不會驅動浮球阻斷濾網。**

4. If brush stops, the circuit breaker may have been tripped. Unplug power cord, check brush for obstruction. Push brush reset button to resume (Figure 7).
4. 若刷子停下，斷路器可能已被絆住，請拔下電源線，檢查刷子是否有阻礙物，壓下刷子重設鈕恢復工作 (圖 7)。



FIG. 7 (圖 7)

5. To clean heavily soiled areas, repeat cleaning path from different direction.
5. 若要清洗非常髒污的區域，請從不同的方向，重複清洗的路線。
6. Observe recovery site window, when recovery appears to stop, drain recovery tank (See DRAINING TANKS).
6. 觀察回收站點窗，當回收停下時，抽乾回收槽 (參見排水槽)。

## CLEANING WITH ACCESSORY TOOLS

### 用附屬工具清洗

1. Connect accessory tool hoses to solution hose coupler and vacuum hose port located at front of machine (Figure 8).
1. 將附屬工具軟管，連接位於機器前側的溶劑軟管耦合器和吸塵器軟管埠 (圖 8)。

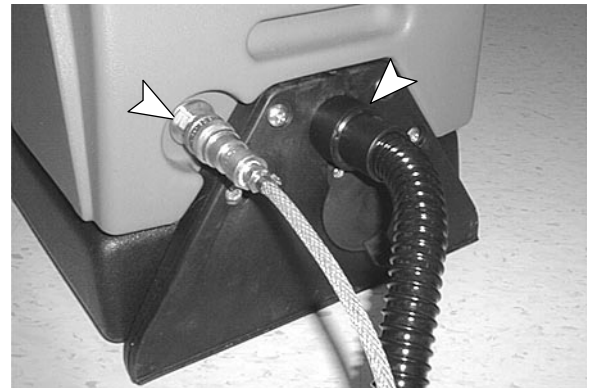

FIG. 8 (圖 8)

2. Turn main power switch on (Figure 9).
2. 開啟電源開關 (圖 9)。



FIG. 9 (圖 9)

3. Operate accessory tools as normal (Figure 10).
3. 操作附屬工具於正常狀態 (圖 10)。

**NOTE:** When cleaning upholstery, always check cleaning instructions sewn in furniture by manufacturer.

**注意：**當清洗室內裝潢時，一定要檢查製造商縫製在家俱上的清洗指示。



FIG. 10 (圖 10)

4. After cleaning, relieve water pressure from tool before disconnecting hose. Squeeze trigger for five seconds after turning main power switch off.
4. 清洗後，在拔下軟管之前，請先減輕工具的水壓。在關閉電源開關之後，請擠壓觸發器 5 秒鐘。

## DRAINING TANKS 排水槽

**FOR SAFETY:** When servicing machine, unplug cord from wall outlet.

**安全起見：**維修機器時，請先從牆上的插座拔下電源線。

## DRAINING RECOVERY TANK 排水回收槽

1. Turn machine off and unplug power cord.
1. 關閉機器並拔下電源線。
2. Hinge open cover, lift recovery tank out and empty (Figure 11).
2. 鏈住開啟蓋，抬出回收槽並倒空 (圖 11)。



FIG. 11 (圖 11)

**NOTE:** Make sure to rinse out recovery tank before refilling solution tank.

**注意：**在重新填裝溶劑槽之前，請務必沖洗回收槽。

## OPERATION 操作

### DRAINING SOLUTION TANK 排水溶劑槽

1. Pull solution tank drain hose off of hose barb at rear of machine and empty remaining solution (Figure 12).
1. 將溶劑槽排水軟管拉離位於機器後側的軟管倒鉤 (圖 12)。



FIG. 12 (圖 12)

2. Replace drain hose.
2. 更換排水軟管。

### MACHINE MAINTENANCE 機器維修

To keep machine in good working condition, simply follow machine's daily, weekly and monthly maintenance procedures.

要保持機器於良好工作狀況，只要簡單地遵循機器每日、每週和每月的維修程序。

**FOR SAFETY: When servicing machine, unplug cord from wall outlet.**

**安全起見：維修機器時，請先從牆上的插座拔下電源線。**

### DAILY MAINTENANCE

(Every 4 Hours of Operation)

每日的維修 (每操作 4 小時)

1. Empty and rinse out recovery tank thoroughly (Figure 13).
1. 徹底倒空和清洗回收槽 (圖 13)。



FIG. 13 (圖 13)

2. Remove float shut-off screen from recovery tank cover and clean (Figure 14).
2. 自回收槽蓋處，移去浮動的阻斷濾網，並加以清洗 (圖 14)。

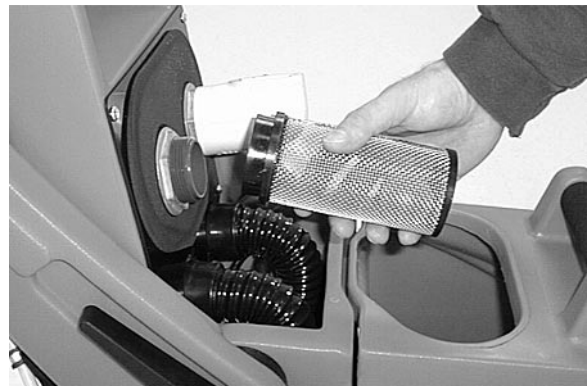

FIG. 14 (圖 14)

3. Drain remaining water from solution tank (Figure 15).

3. 排空溶劑槽內剩餘的水 (圖 15)。



FIG. 15 (圖 15)

6. Remove any debris lodged in pick up head (Figure 17).

6. 除去附著在拾取頭上的任何碎片 (圖 17)。

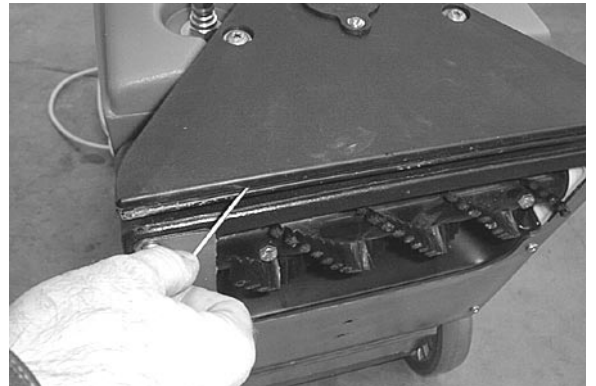

FIG. 17 (圖 17)

4. Clean solution tank fill port strainer.

4. 清洗溶劑槽填裝埠過濾器。

5. Remove any entangled carpet fibers and debris from brush (Figure 16).

5. 除去刷子上任何纏在一起的地氈纖維和碎片 (圖 16)。

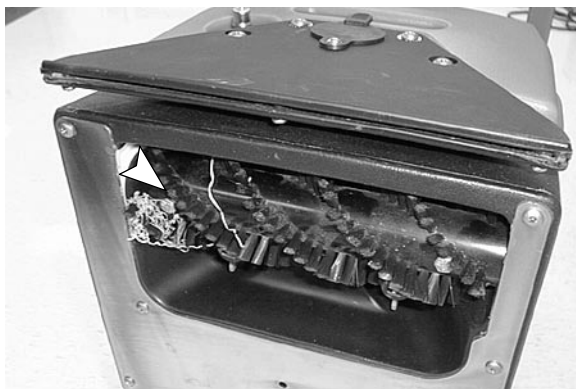

FIG. 16 (圖 16)

7. Wipe off power cord and check for damage, replace if necessary. Coil cord neatly after use.

7. 擦拭電源線，檢查是否受損，若有必要，可加以替換。使用後，請將電源線盤繞整齊。

8. Clean machine with an all purpose cleaner and damp cloth (Figure 18).

8. 以萬用的清潔劑和濕布，清洗機器 (圖 18)。



FIG. 18 (圖 18)

# OPERATION 操作

## WEEKLY MAINTENANCE

(Every 20 Hours of Operation)

每週的維修 (每操作 20 小時)

1. Inspect vacuum hoses for holes and loose cuffs.
1. 檢查吸塵器軟管是否有破洞和寬鬆反摺的情形。
2. Inspect spray pattern for plugging. If plugged, remove spray tips and soak them in a recommended liquid neutralizer for up to six hours. To remove spray tip, twist spray tip body counter-clockwise. Do not use pointed objects to unplug tips, damage will occur (Figure 19).
2. 檢查插入的噴灑類型，若插著，請移去噴灑尖嘴，泡在建議的液態中性劑達 6 個小時。若要移去噴灑尖嘴，請將噴灑尖嘴本體逆時針旋轉。勿使用尖物來拔下尖嘴，否則將會發生受損的情況 (圖 19)。

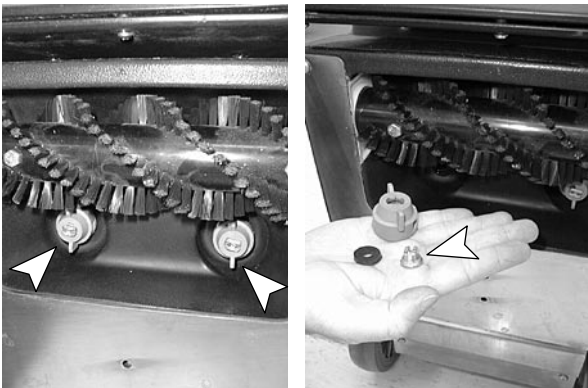

FIG. 19 (圖 19)

**FOR SAFETY: When using machine, follow mixing and handling instructions on chemical containers.**

**安全起見：使用機器時，請遵循化學容器上的混合和處理指示。**

3. Inspect cord and cord grip for damage. Replace immediately if damaged.
3. 請檢查電源線和電源線握柄是否有損壞，如有損壞，請立即更換。

## MONTHLY MAINTENANCE

(Every 80 Hours of Operation)

每月的維修 (每操作 80 小時)

1. Flush solution system with a recommended liquid neutralizer to dissolve normal chemical buildup.
1. 請以建議的液態中性劑沖洗溶劑系統，來溶解一般的化學組織。
  - a. Pour 7.5L (2 gal) of hot water 60 °C (140 °F) into solution tank. Add a liquid neutralizer according to mixing instructions on bottle.
  - a. 倒 7.5 公升 (2 加侖)、60 °C (140 °F) 的熱水，至溶劑槽內。請依照瓶上的混合指示，來加入液態中性劑。

**NOTE: Contact your chemical supplier for a recommended neutralizer liquid.**

**注意：聯絡您的化學物品供應商，請求建議中性劑。**

**FOR SAFETY: When using machine, follow mixing and handling instructions on chemical containers.**

**安全起見：使用機器時，請遵循化學容器上的混合和處理指示。**

- b. Position brush over floor drain and operate machine for one minute.
  - b. 將刷子置放於地板排水 (floor drain)，操作機器一分鐘。
  - c. Then connect hand tool solution hose to machine and also over a floor drain operate tool for one minute.
  - c. 接著，將手動工具溶劑軟管連到機器上，並且在地板排水上，操作工具一分鐘。
  - d. Shut off machine and allow remaining solution to break down chemical buildup overnight.
  - d. 關閉機器，讓剩餘的溶劑用整夜的時間來分解化學組織。
  - e. Next day, spray out remaining solution and flush system with 11L (3 gal) of clean water.
  - e. 隔天，噴灑剩餘的溶劑，用 11 公升 (3 加侖) 的清水來沖洗系統。
2. Lubricate wheels with a water resistant oil.
  2. 以防水的油脂來潤滑輪子。
  3. Inspect machine for water leaks and loose hardware.
  3. 檢查機器漏水和 loose 硬體。

**QUARTERLY MAINTENANCE**

(Every 250 Hours of Operation)

每季的維修（每操作 250 個小時）

Check vacuum motor for carbon brush wear. Replace brushes if worn to a length of 10mm (0.38 in) or less. Contact an Authorized Service Center for motor maintenance.

檢查吸塵器馬達的碳刷磨損情形，若是磨損到只剩 10 公釐（0.38 英吋）或更短的長度時，請更換碳刷。馬達維修，請聯絡授權的服務中心。

**STORING MACHINE 貯存機器**

1. Before storing machine, be certain to drain and rinse tanks of all water.
1. 在貯存機器之前，請確定要排水及沖洗所有水槽。
2. Store machine in a dry area in the upright position.
2. 將機器倒立貯存在乾燥的區域。
3. Open recovery tank cover to promote air circulation.
3. 將回收槽蓋打開，促進空氣流通。

**ATTENTION: Do not expose to rain. Store indoors.**

注意：勿暴露在雨中，請貯存在戶內。

**ATTENTION: If storing machine in freezing temperatures, be sure that machine and solution system are completely drained and dry.**

注意：若機器存放在冰溫狀況下，請確定機器和溶劑系統已完全排空水份並且保持乾燥。

**RECOMMENDED STOCK ITEMS**

建議的庫存項目

Refer to Parts List section for recommended stock items. Stock Items are clearly identified with a bullet preceding the parts description. See example below:

參考零件清單的單元，查看建議的庫存項目。庫存項目在零件說明前，有子彈標誌可清楚識別。

參考 Ref.	零件號碼 Part No.	說明 Description	數量 Qty.
1	701103	ASM., STANDPIPE	1
2	180613	●FLOAT, SHUTOFF	1
3	230187	NIPPLE	1
4	101714	●GASKET	1
5	210240	NUT, FLANGED	1

# OPERATION 操作

## TROUBLE SHOOTING

PROBLEM	CAUSE	SOLUTION
Machine does not operate.	Faulty switches or wiring.	Contact Service Center.
	Faulty power cord.	Contact Service Center.
	Building circuit breaker tripped.	Reset breaker.
Brush motor does not operate.	Brush motor circuit breaker tripped.	Let motor cool and reset brush motor breaker button at rear of machine.
	Triggers not pulled.	Pull brush/solution triggers.
	Loose or broken brush belt.	Contact Service Center.
	Faulty trigger switch or wiring.	Contact Service Center.
	Faulty brush motor.	Contact Service Center.
Solution pump does not operate.	Solution pump circuit breaker tripped.	Let pump cool and reset pump breaker button at rear of machine.
	Triggers not pulled.	Pull brush/solution triggers.
	Faulty trigger switch or wiring.	Contact Service Center.
	Faulty solution pump motor.	Contact Service Center.
Vacuum motor does not operate.	Loose or broken wiring.	Contact Service Center.
	Faulty main power switch.	Contact Service Center.
	Defective vacuum motor.	Contact Service Center.
	Worn carbon brushes.	Contact Service Center.
Poor solution pick-up.	Defective recovery tank cover gasket.	Replace gasket.
	Clogged float shut-off screen.	Open recovery tank cover and clean lint off screen.
	Accessory tool vacuum hose port cover is loose or missing.	Check vacuum hose port cover.
	Loose vacuum hose connections.	Secure connections under cover.
	Defective vacuum hose.	Replace hose.
	Loose vacuum hose cuffs.	Secure cuffs to hose.
	Pulling machine too fast.	Slow down cleaning process.
Uneven or no spray.	Plugged spray tips.	Clean or replace tips.
	Improper spray tip size or spray angle.	Replace with proper tips.
	Clogged solenoid valve.	Contact Service Center.
	Worn spray tips.	Replace spray tips.
	Solution tank low or empty.	Refill solution tank.
	Faulty solution pump.	Contact Service Center.
	Pump needs priming.	Prime pump by pressing solution hose coupler tip located at front of machine.



## 故障排除

問題	原因	解決方法
機器無法操作。	開關或接線有問題。	聯絡服務中心。
	電源線有問題。	聯絡服務中心。
	建置的斷路器有問題。	重設斷路器。
碳刷馬達無法工作。	碳刷馬達的斷路器有問題。	讓馬達冷卻，然後，重設位於機器後側的碳刷馬達斷路器鈕。
	未拉動觸發器。	拉動碳刷／溶劑觸發器。
	碳刷皮帶鬆弛或斷裂。	聯絡服務中心。
	觸發器開關或接線有問題。	聯絡服務中心。
	碳刷馬達有問題。	聯絡服務中心。
溶劑泵無法工作。	溶劑泵斷路器有問題。	讓泵冷卻，然後，重設位於機器後側的泵斷路器鈕。
	未拉動觸發器。	拉動碳刷／溶劑觸發器。
	觸發器開關或接線有問題。	聯絡服務中心。
	溶劑泵馬達有問題。	聯絡服務中心。
吸塵器的馬達無法工作。	繞線鬆弛或斷裂。	聯絡服務中心。
	電源開關有問題。	聯絡服務中心。
	吸塵器的馬達有問題。	聯絡服務中心。
	碳刷馬達磨損。	聯絡服務中心。
溶劑吸取的情況不佳。	回收槽蓋的墊圈有問題。	更換墊圈。
	浮動的阻斷濾網有問題。	開啟回收槽蓋，清洗濾網上的棉絨。
	附屬工具吸塵器軟管埠蓋鬆動或遺失。	檢查吸塵器軟管埠蓋。
	吸塵器軟管的連接有鬆動。	在蓋子下穩固連接。
	吸塵器軟管有問題。	更換軟管。
	鬆弛的吸塵器軟管反摺。	將反摺部分牢固地連接於軟管。
	機器拉得太快。	放慢清洗的過程。
不平均或未噴灑	噴灑尖嘴被插入。	清洗或更換尖嘴。
	噴灑尖嘴的尺寸或噴灑角度不正確。	更換正確的尖嘴。
	螺線管閥有問題。	聯絡服務中心。
	噴灑尖嘴有問題。	更換噴灑尖嘴。
	溶劑槽水位低或已全空	重新裝填溶劑槽。
	溶劑泵有問題。	聯絡服務中心。
	泵需要引水。	加壓位於機器前側的溶劑軟管耦合器尖端，替泵引水。

# OPERATION 操作

## SPECIFICATIONS

<b>Model</b>	<b>TENNANT 1200</b>
LENGTH	533 mm (21 in) with handle folded
WIDTH	330 mm (13 in)
HEIGHT	749 mm (29.5 in) with handle folded
WEIGHT	27 Kg (60 lb)
SOLUTION TANK CAPACITY	15 L (4 gal)
RECOVERY TANK CAPACITY	15 L (4 gal)
CLEANING PATH WIDTH	273 mm (10.75 in)
MAXIMUM CLEANING RATE	130 m <sup>2</sup> (1,400 sq. ft.) per hour
BRUSH MOTOR	230VDC, 0 .1HP, .38A, 90W, 1800 rpm - no load
BRUSH SPEED	1038 rpm - no load
SOLUTION PUMP	230VAC, 4.5 bar (65psi), .25A, 4.5 LPM (1.2 GPM)
VACUUM MOTOR	230VAC, 1.4 HP, 4.7A, 1046W, 2 stage, 105 cfm
SEALED WATER LIFT	2514mm (99 in)
TOTAL POWER CONSUMPTION	230VAC, 5.3A, 1249 W
POWER CORD	3X1.5MM <sup>2</sup> X15M (50ft.) -230V
DECIBEL RATING AT OPERATOR'S EAR, INDOORS ON CARPET	<72 dB(A)

## MACHINE DIMENSIONS

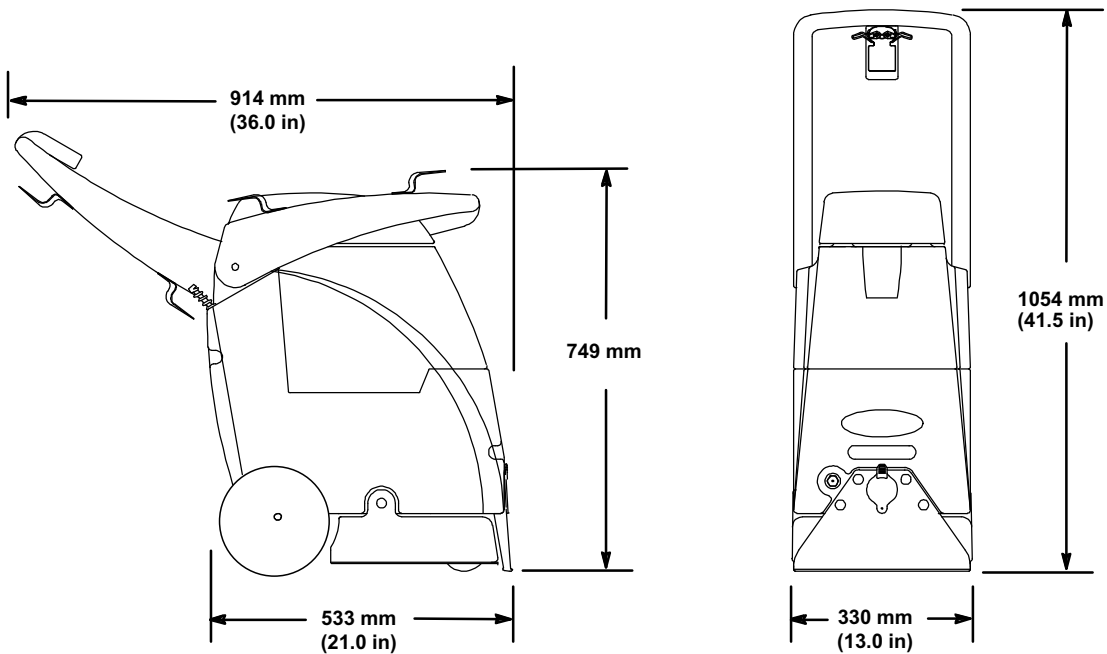

規格

機型	TENNANT 1200
長度	把手摺起時， 533 公釐 (21 英吋)
寬度	330 公釐 (13 英吋)
高度	把手摺起時， 749 公釐 (29.5 英吋)
重量	27 公斤 (60 英磅)
溶劑槽容量	15 公升 (4 加侖)
回收槽容量	15 公升 (4 加侖)
清洗路線的寬度	273 公釐 (10.75 英吋)
清洗的最快速率	每小時， 130 平方公尺 (1,400 平方英尺)
碳刷馬達	無負載時， 230 伏特直流電， 0.1HP， 38 安培， 90 瓦， 每分鐘 1800 轉
碳刷速度	無負載時， 每分鐘 1038 轉
溶劑泵	230 伏特直流電， 4.5 巴爾 (65psi)， 25 安培， 4.5LPM (1.2 群組 M)
吸塵器馬達	230 伏特直流電， 1.4HP， 4.7 安培， 1046 瓦， 兩階段， 105cfm
封裝水的揚升	2514 公釐 (99 英吋)
總消耗功率	230 伏特直流電， 5.3 安培， 1249 瓦
電源線	3x1.5 平方公尺 x15 米 (50 英尺) – 230 伏特
在室內的地氈上，操作人員耳朵承受的分貝比	<72 分貝 (A)

機器尺寸

